



DATOS MOTOR

POTENCIA	3HP
REVOLUCIONES	1760
FRECUENCIA	60HZ
TORQUE MOTOR NOMINAL	12,2
CARCASA (PAM)	90(B5)
TIPO BRIDA	FF-165
EFICIENCIA MOTOR	IE 2

DATOS REDUCTOR

REFERENCIA	550013
TIPO	ORTOGONAL
MODELO	FCN
MATERIAL	ALUMINIO
CARCASA	75
RELACION DE TRANSMISION i:	20
VELOCIDAD SALIDA	88,00
TORQUE MAXIMO	209
TORQUE OPERACIÓN	200
FACTOR DE SERVICIO	1,0

PLANOS REDUCTOR

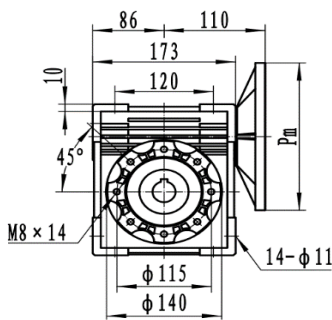

FCN 75

Input shaft hole

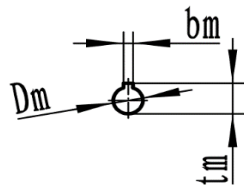

Output shaft hole

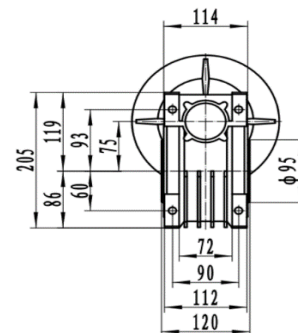
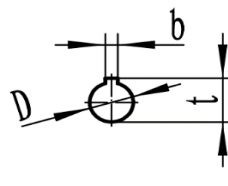

Dimensions of output shaft				
D	H7	b	D10	t
28		8		31.3

	Pm	Dm	bm	tm
71B5	160	14	5	16.3
80B5	200	19	6	21.8
80B14	120			
90B5	200	24	8	27.3
90B14	140			
100/112B5	250	28	8	31.3
100/112B14	160			